



CHIEFTEK PRECISION CO., LTD.

cpcRobot



cpcStudio

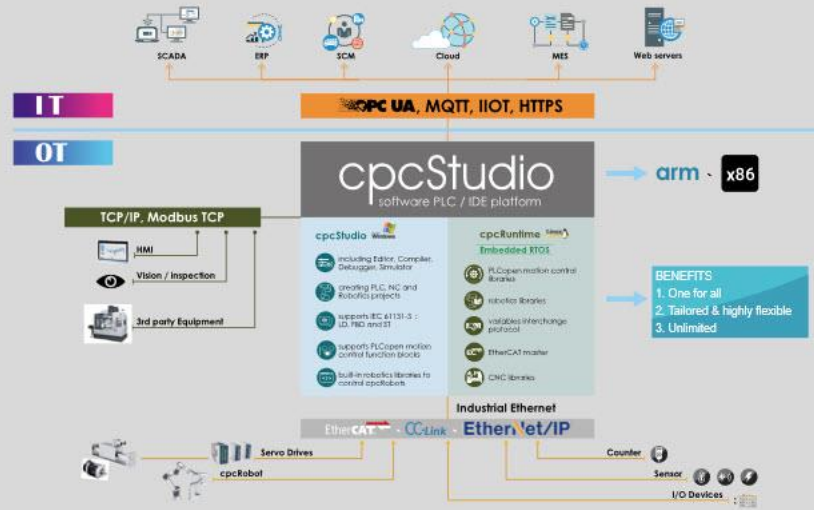

cpcCells

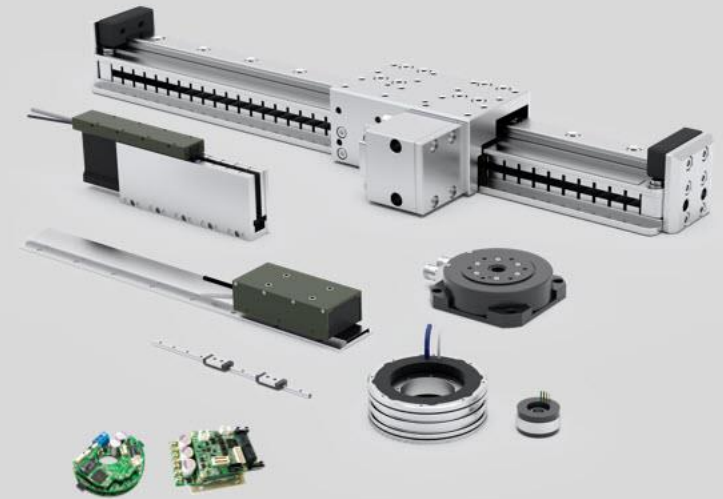

Special assistant to president / Athena Hsu

cpc's Founders



Angelika Chen

Chairperson & CEO

Art History of Universität Stuttgart



Anton Hsu

President

Diplom Ingenieur of Mechanical Engineering of
Universität Stuttgart

MILESTONE

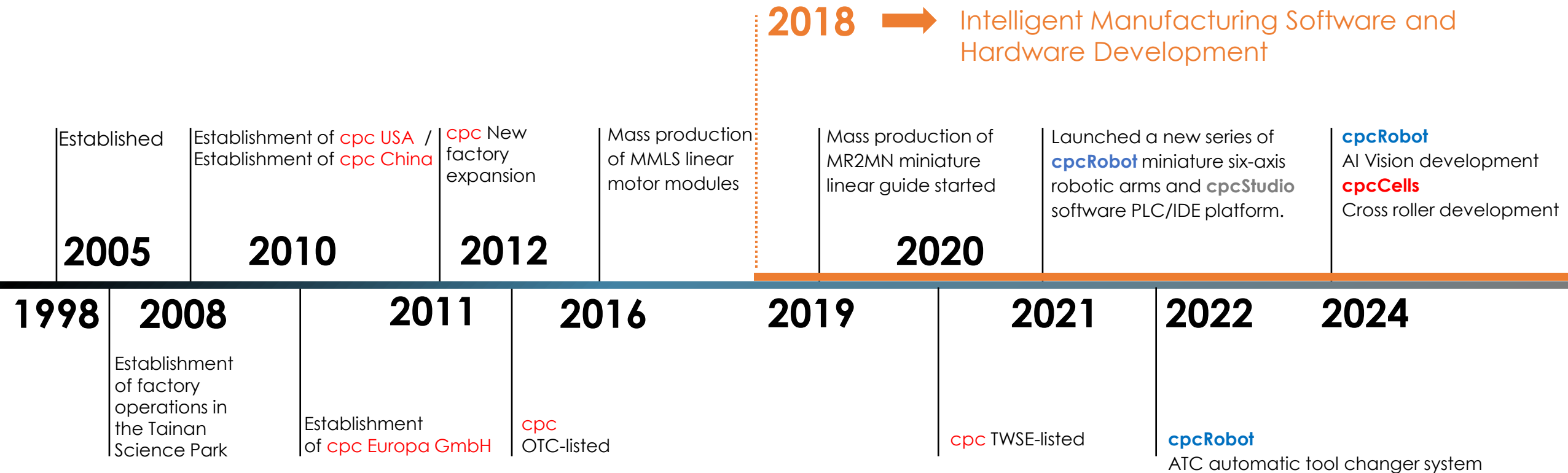

CHIEFTEK PRECISION CO., LTD.

Not only for users, but also for designers
cpc's products inspire you!
 Together with cpc to achieve new levels of innovation!

Organizational chart

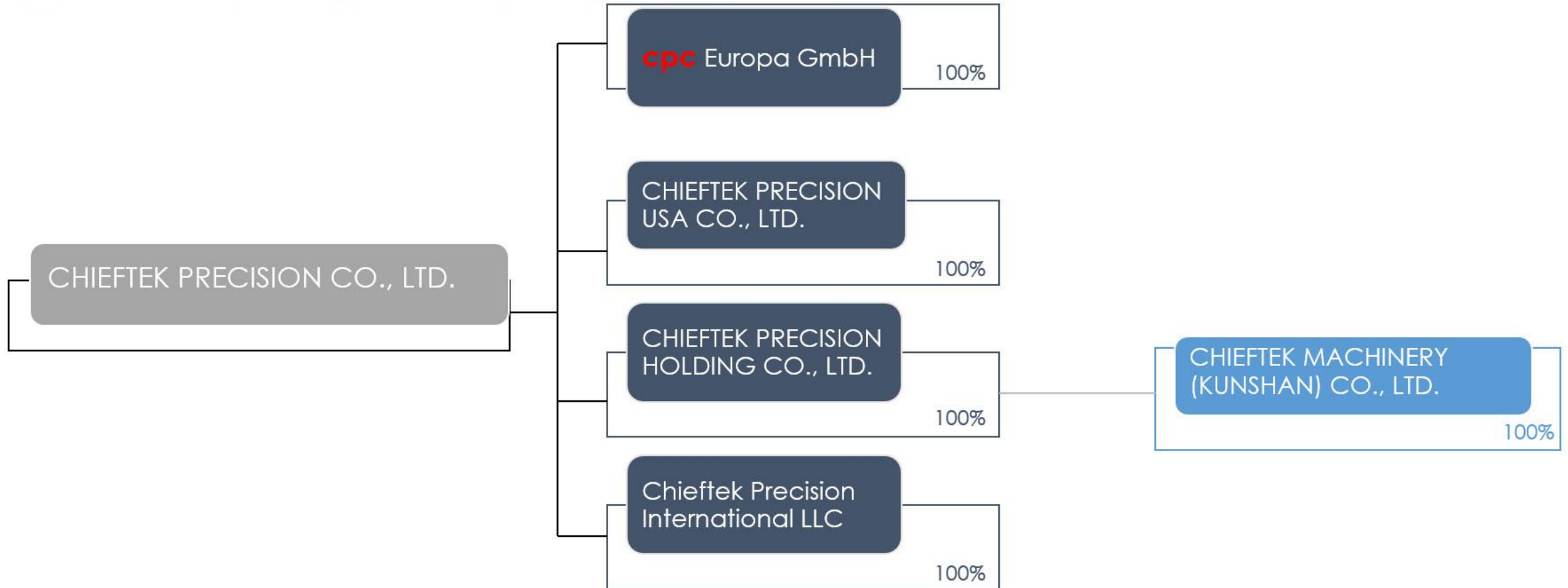

cpc Global Locations

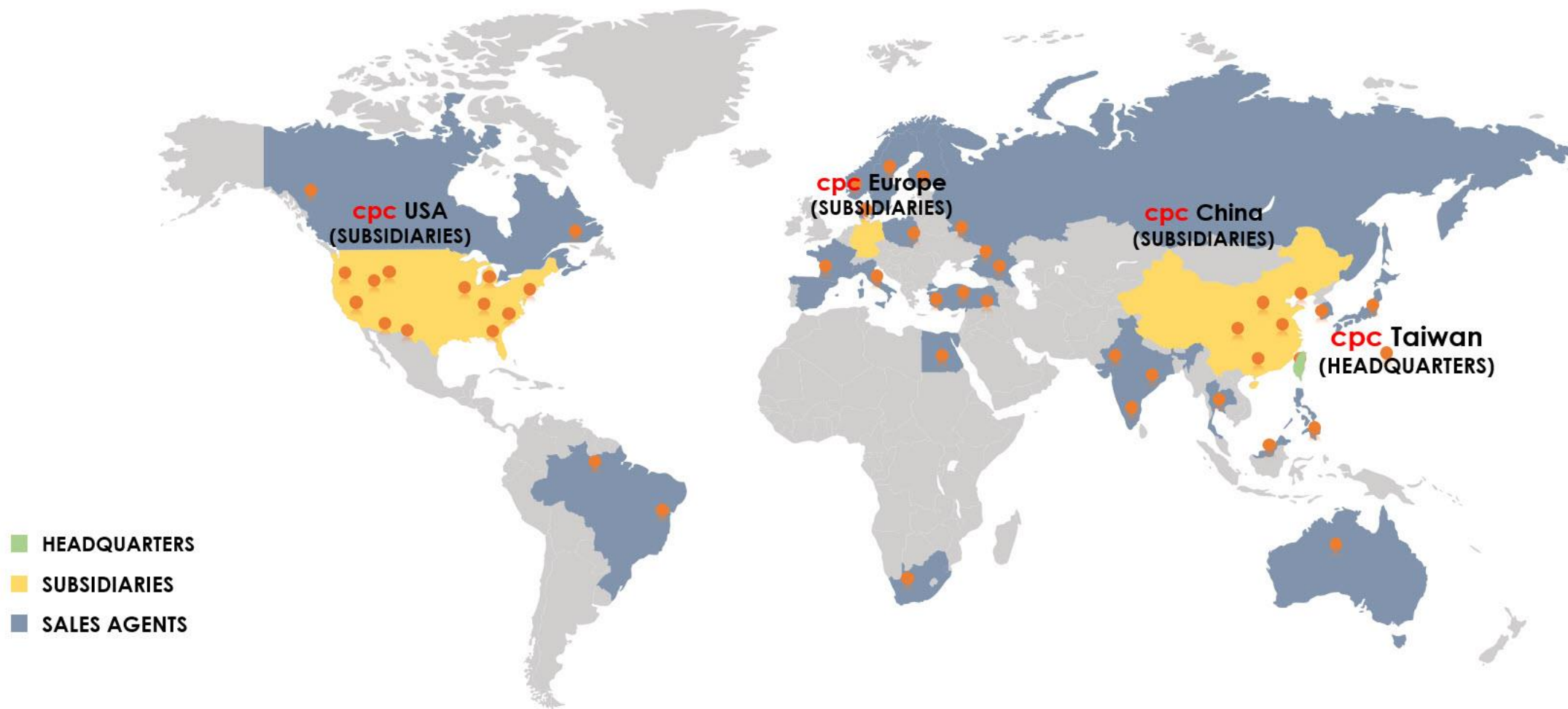

CHIEFTEK PRECISION CO., LTD.

Not only for users, but also for designers
cpc's products inspire you!
Together with cpc to achieve new levels of innovation!

cpc HEADQUARTERS

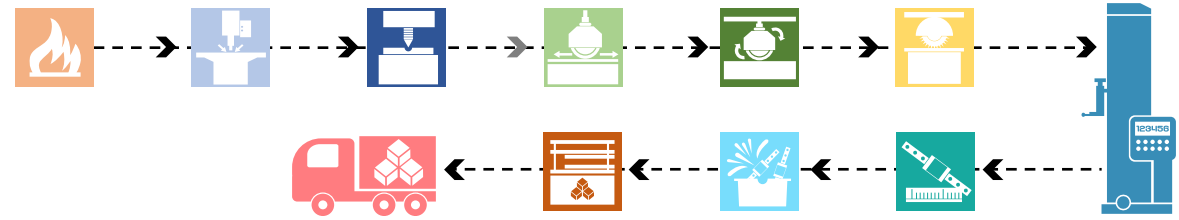

CHIEFTEK PRECISION CO., LTD.

Not only for users, but also for designers
cpc's products inspire you!
Together with cpc to achieve new levels of innovation!

TREE VALLEY

Total solar power generation 1.35MW



cpc Smart Factory Architecture Content in Tree Valley



cpc Smart management

IIOT

Information security

Remote order

Capacity return

Monitoring room

Production Planning & Scheduling

Manufacturing Execution System (MES)

Material management (MRP/LRP)

Equipment maintenance and real-time monitoring

cpc Equipment automation

1. Automation of material Handling (automatic storage system, unmanned guided vehicle, automated material transportation)
2. Equipment automation (centralization of processing systems - cooling, suction, filtration, waste etc.)
(Component/Drive/Control System - Integrated Unified Platform)
3. Process automation (process management, fixture management, tool management)
4. QC automation (automatic measurement record, automatic data feedback, automatic process correction)
5. Assembly and packaging automation

cpc USA



cpc China



Warehouse



Sales



Finishing



Application Engineering



cpc Europe



Warehouse



Sales



Finishing



Application Engineering



New Investment in Germany

cpc's new plant in Geisingen



CHIEFTEK PRECISION CO., LTD.

Not only for users, but also for designers
cpc's products inspire you!
Together with cpc to achieve new levels of innovation!

cpc's new plant in Geisingen



CHIEFTEK PRECISION CO., LTD.

Not only for users, but also for designers
cpc's products inspire you!
Together with cpc to achieve new levels of innovation!

cpc Global Exhibitions and Events

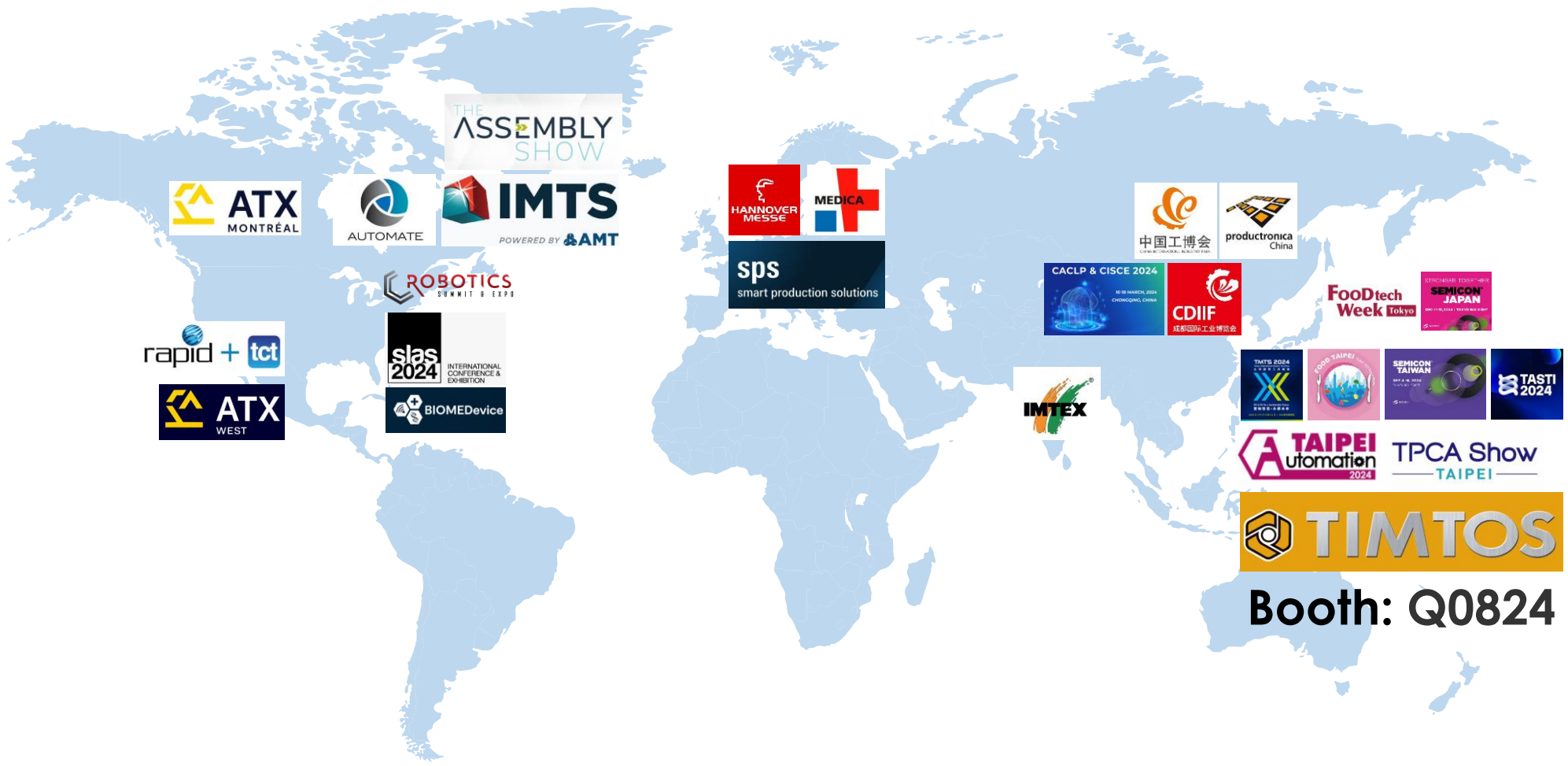

CHIEFTEK PRECISION CO., LTD.

Not only for users, but also for designers
cpc's products inspire you!
 Together with cpc to achieve new levels of innovation!



2021 Industrial automation Gold

cpcCells

Linear guide series,
Servo motor series,
Sensor series,
Servo drive series,
Linear / Torque motor stage series



cpcRobot

Miniature High Precision 6-Axis
Robotic Arm - S0, DB0 series
Automatic tool changer - ATC series
VA Vacuum gripper



cpcStudio

PLC / IDE platform
software PLC / IDE platform

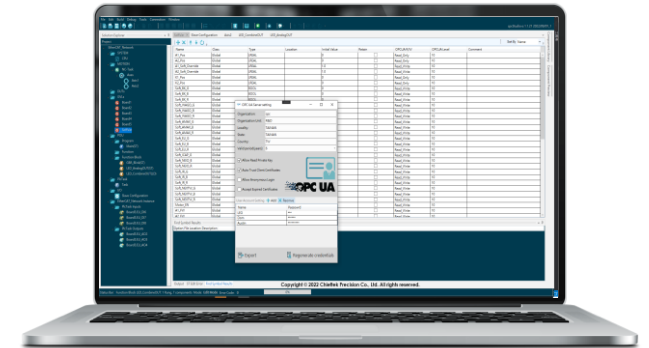

CHIEFTEK PRECISION CO., LTD.

Not only for users, but also for designers
cpc's products inspire you!
Together with cpc to achieve new levels of innovation!

Cross Roller



High precision, long service life

Low noise, low friction resistance,
and vibration-free linear motion.



Exclusive Design

**Integrated through-type oil
reservoir design**

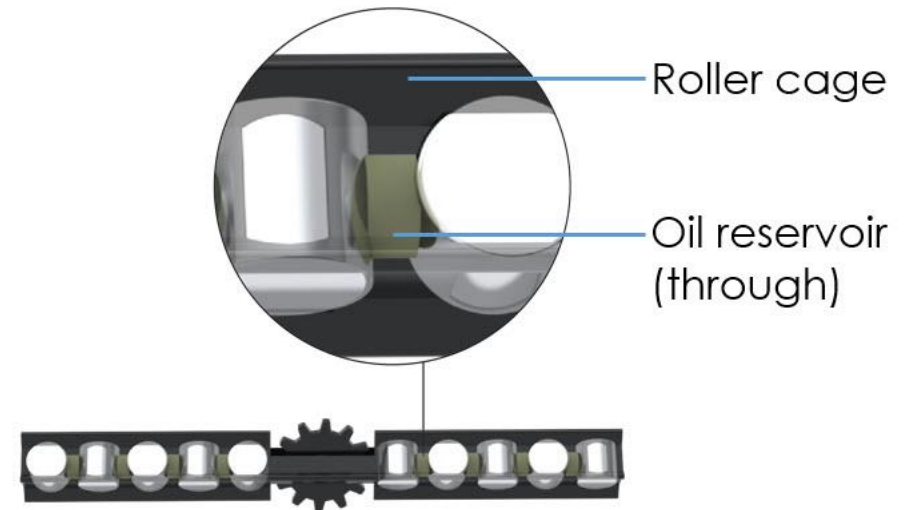

CHIEFTEK PRECISION CO., LTD.

cpcCells

Not only for users, but also for designers
cpc's products inspire you!
Together with cpc to achieve new levels of innovation!

Smart manufacturing

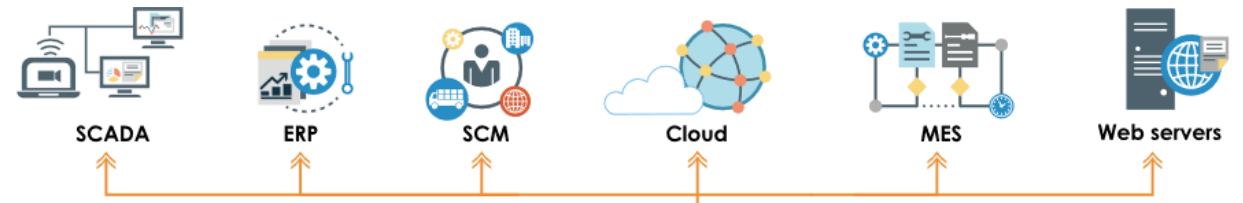

OPC UA, MQTT, IIOT, HTTPS

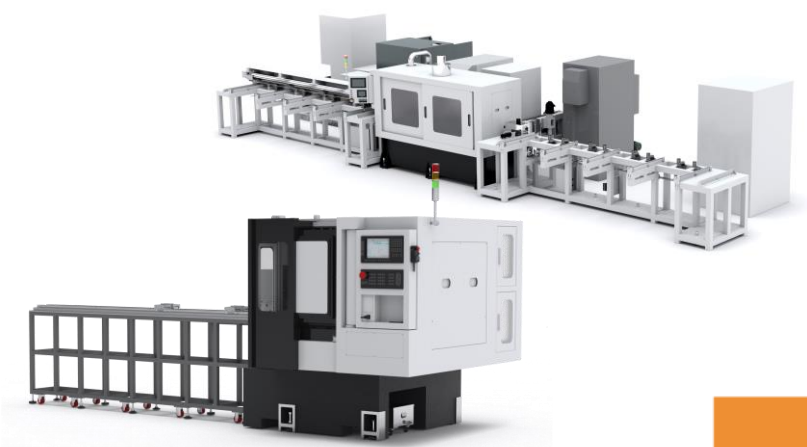

cpcStudio
software PLC / IDE platform

cpcStudio Windows	cpcRuntime Linux Embedded RTOS
including Editor, Compiler, Debugger, Simulator	PLCopen motion control libraries
creating PLC, NC and Robotics projects	robotics libraries
supports IEC 61131-3 : LD, FBD and ST	variables interchange protocol
supports PLCopen motion control function blocks	EtherCAT master
built-in robotics libraries to control cpcRobots	CNC libraries



EtherCAT

cpcCells



Service Expansion

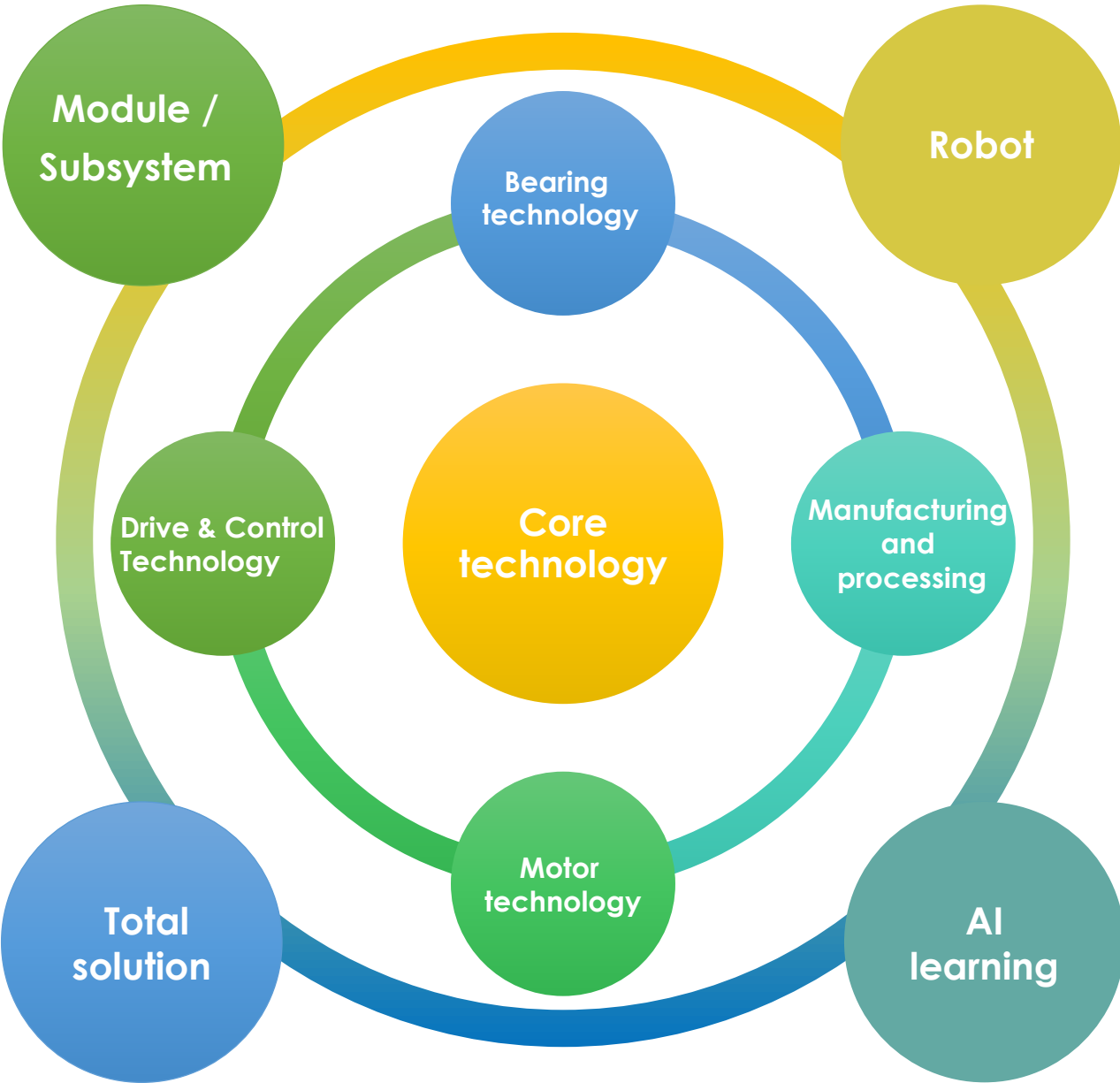

CHIEFTEK PRECISION CO., LTD.

Not only for users, but also for designers
cpc's products inspire you!
Together with cpc to achieve new levels of innovation!



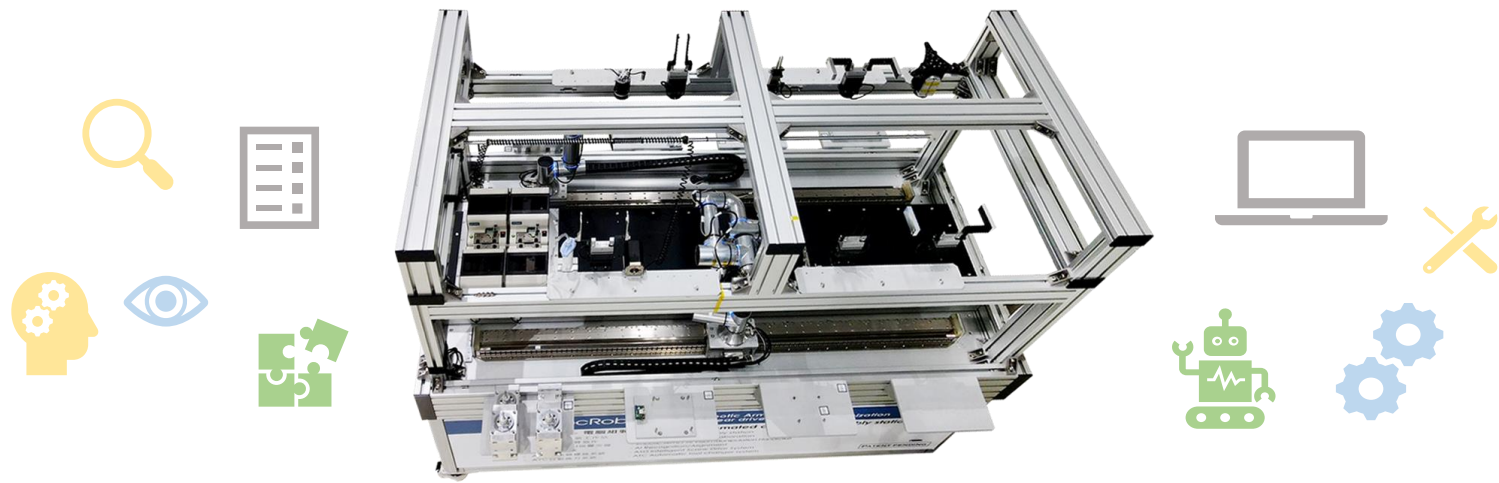
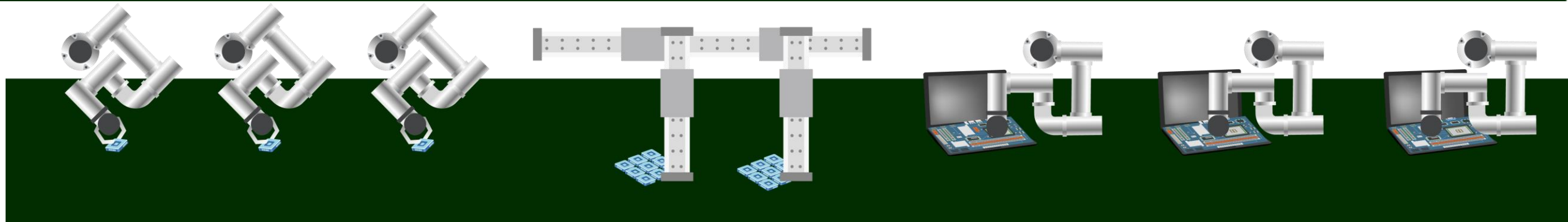

CHIEFTEK PRECISION CO., LTD.

cpcRobot

Not only for users, but also for designers
cpc's products inspire you!
Together with cpc to achieve new levels of innovation!

ATC fast automatic tool changer / Multi-tasks

S0 6 DoF robot arm with linear actuators

Vision task

ASD automated screwdriving

Assembly area

Material input area

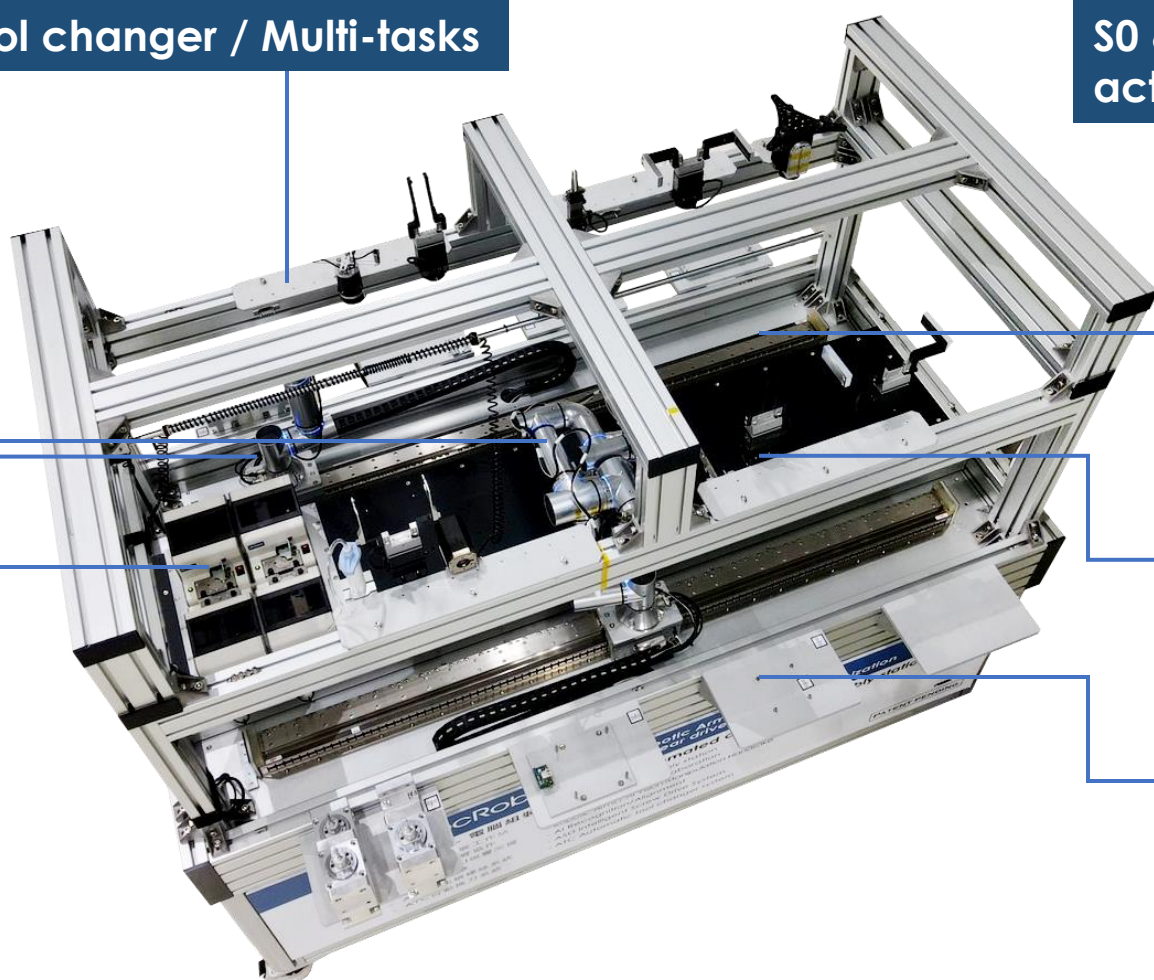

CHIEFTEK PRECISION CO., LTD.

cpcRobot

Not only for users, but also for designers
cpc's products inspire you!
Together with cpc to achieve new levels of innovation!



cpcRobot

Copyright © 2024 Chieftek Precision Co., Ltd. All rights reserved.

CHIEFTEK PRECISION CO., LTD.

cpcRobot

Not only for users, but also for designers
cpc's products inspire you!
Together with cpc to achieve new levels of innovation!

cpc Development of AI Vision and Motion Control (Robotics)



Hand-Eye Interaction Model

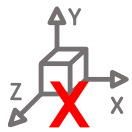

Abandon the concept of coordinate systems to achieve **rapid alignment** and coordinated movement of multiple arms.

Human-like Work Objectives



- General Work
- Complex Work
- High-Precision Work

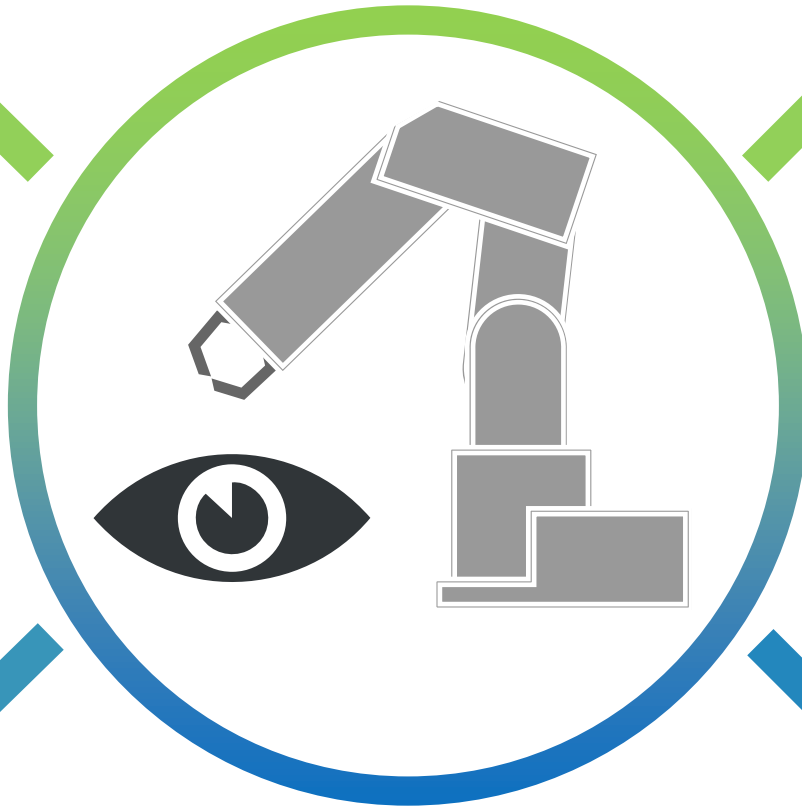

- Stability, Automatic Detection
- Speed / Accuracy
- Small-Batch Diverse Work (Easy to change production lines)

1 mm / 0.1 mm	10 μm / 1 μm
Man-made	Beyond human



Accuracy Requirement

Work Goals



Layout of Low Earth Orbit Satellites

 TASA + **cpc**

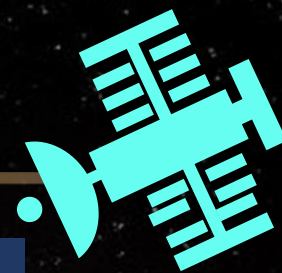

Satellite

Gimbal



Ground test station



Control center **cpcStudio**

Rocket

Propulsion, control valve

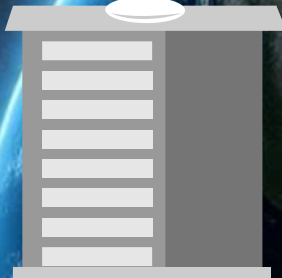

CHIEFTEK PRECISION CO., LTD.

cpcRobot

Not only for users, but also for designers
cpc's products inspire you!
Together with cpc to achieve new levels of innovation!

Financial Report

Financial Report

CHIEFTEK PRECISION CO., LTD.

Not only for users, but also for designers
cpc's products inspire you!
Together with cpc to achieve new levels of innovation!

Revenue Trend Chart by Product for 2020 to 2024

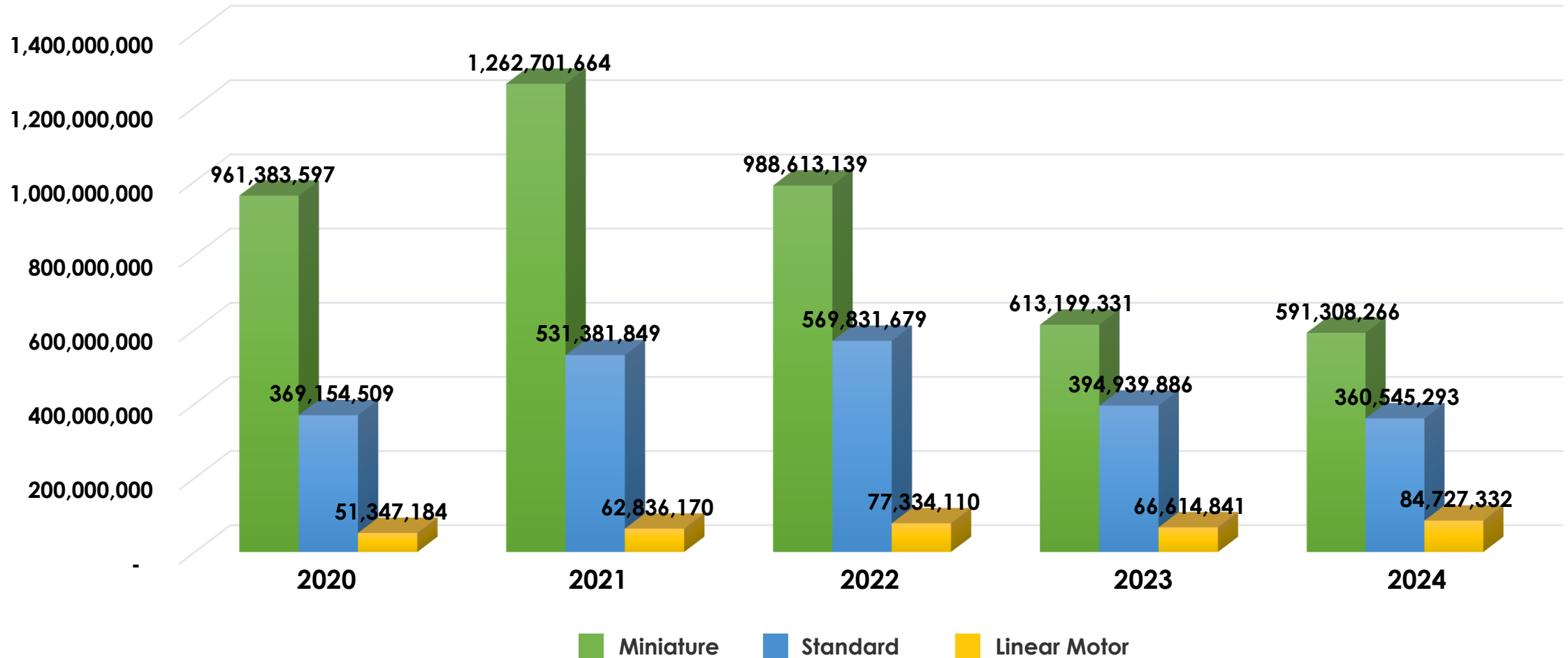

CHIEFTEK PRECISION CO., LTD.

Not only for users, but also for designers
cpc's products inspire you!
Together with cpc to achieve new levels of innovation!

Revenue Share by Region for 2022 to 2024

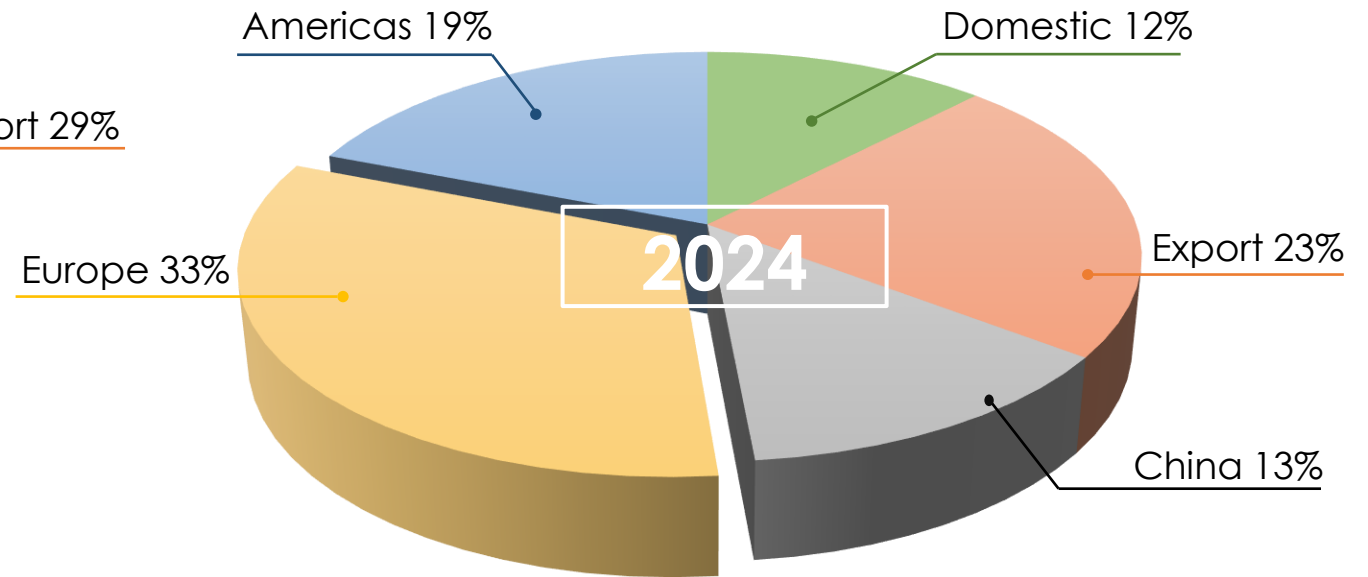
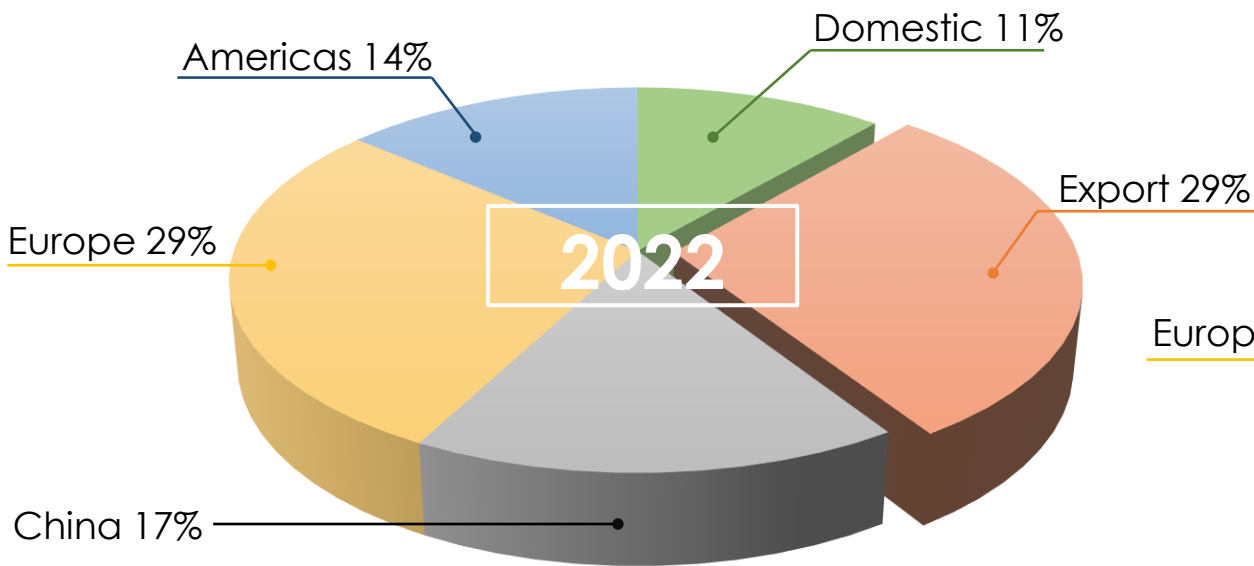
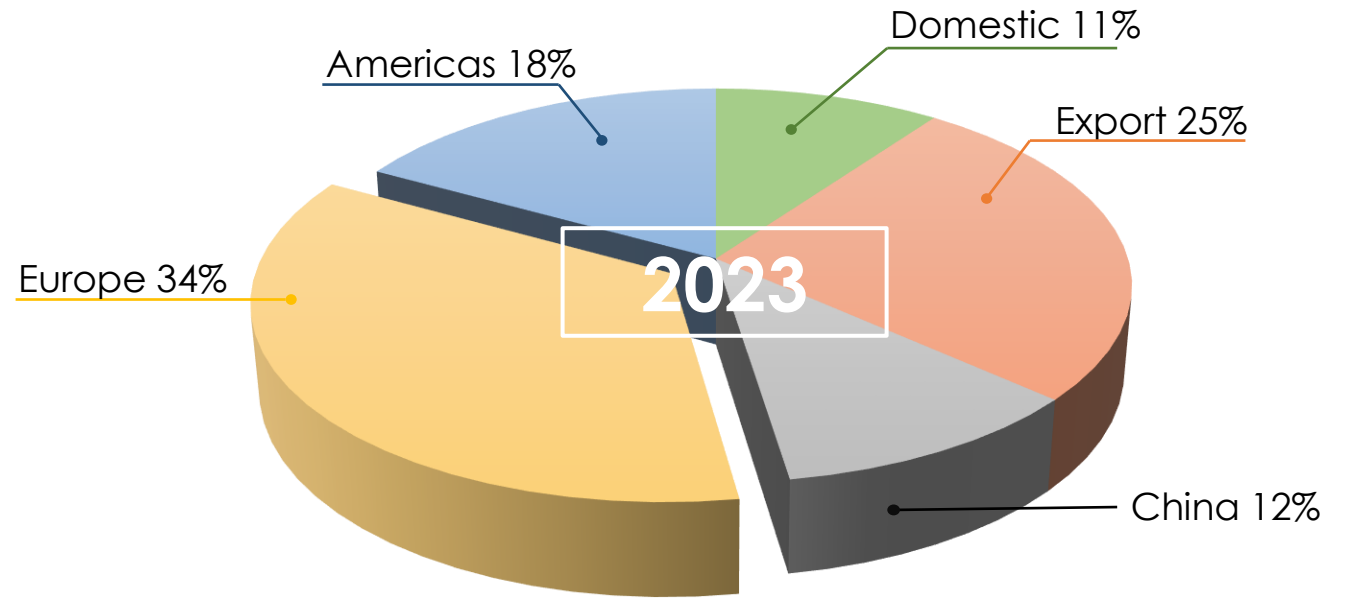

Revenue Share by Region for Domestic and Export Sales for 2023 to 2024

Domestic Export

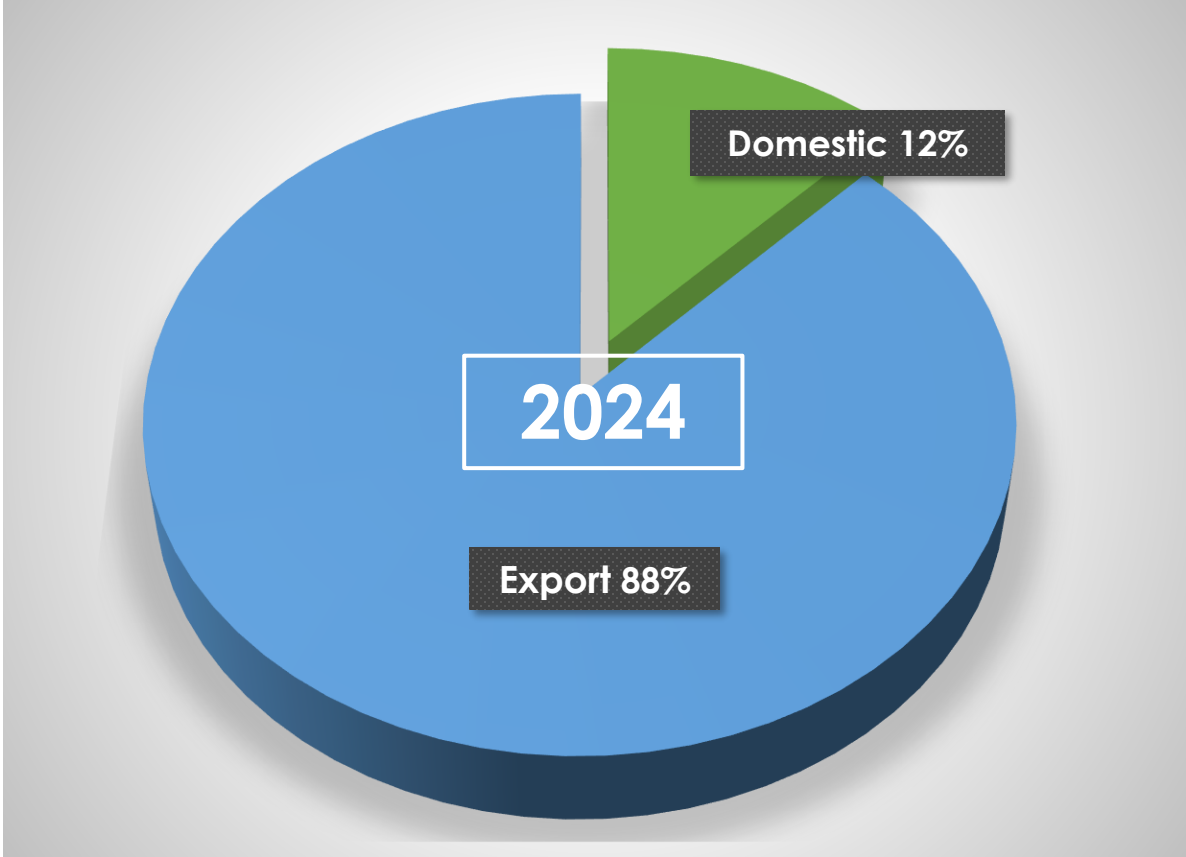
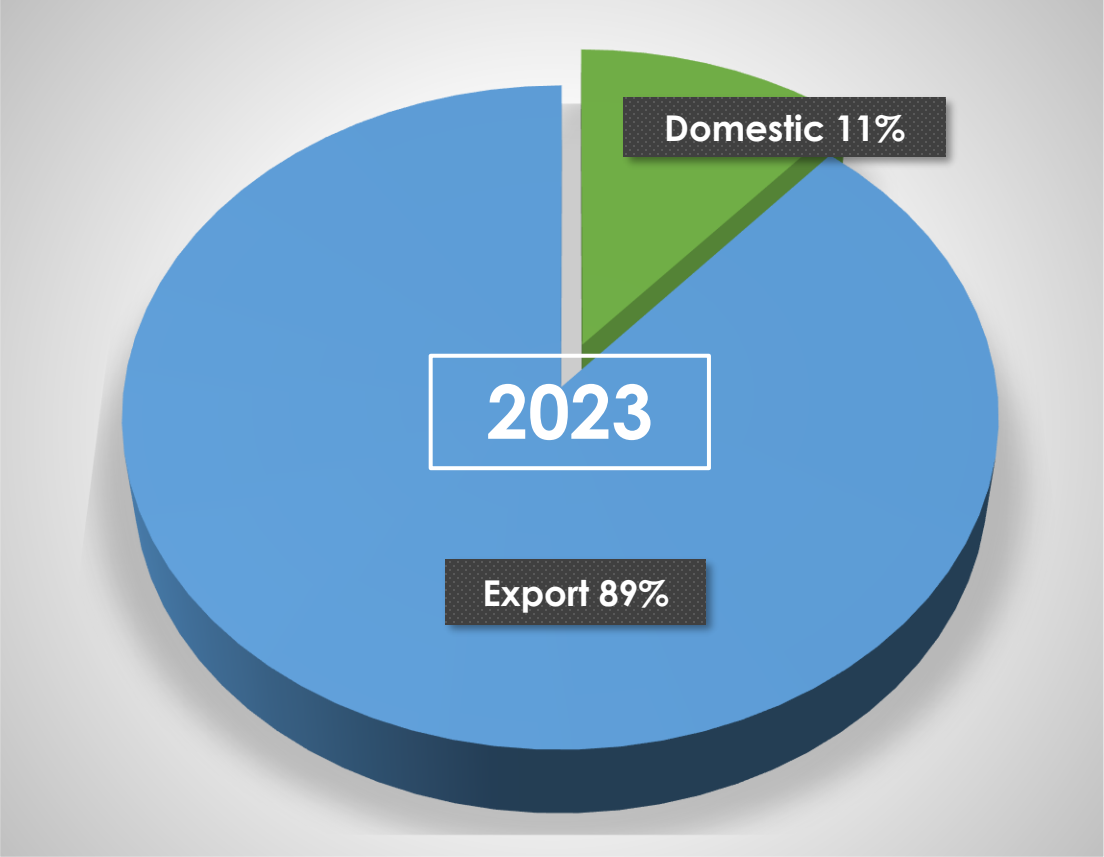

CHIEFTEK PRECISION CO., LTD.

Not only for users, but also for designers
cpc's products inspire you!
Together with cpc to achieve new levels of innovation!

Gross Margin and Earnings Per Share Trend Chart for 2020 to 2024

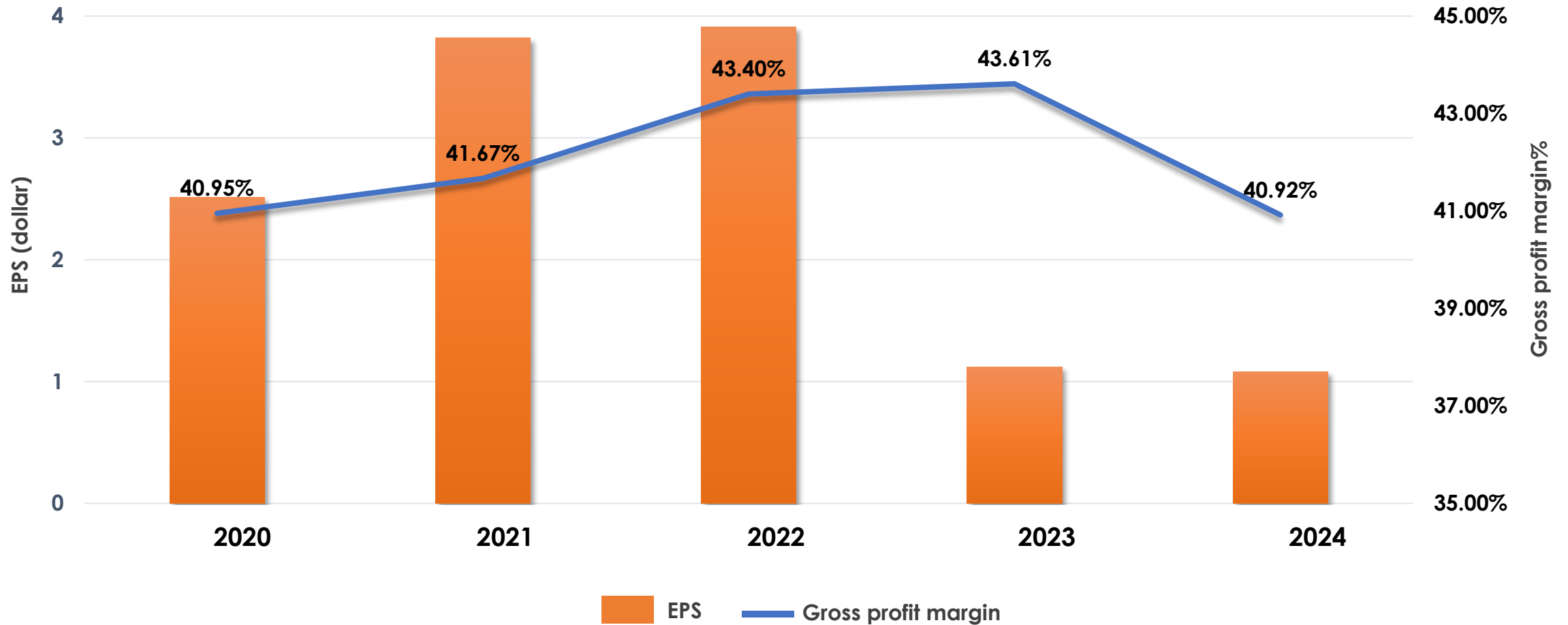

CHIEFTEK PRECISION CO., LTD.

Not only for users, but also for designers
cpc's products inspire you!
Together with cpc to achieve new levels of innovation!

Dividend Policy

Currency : NTD

Profitable Year	Cash Dividend	Stock Dividend	Total
113 ^{Note}	0.7	0.0	0.7
112	0.8	0.0	0.8
111	2.0	0.0	2.0
110	1.5	1.0	2.5
109	1.5	0.0	1.5
108	1.0	0.0	1.0
107	1.0	1.0	2.0
106	1.0	2.5	3.5

Note: Approved by the board of directors on February 26, 2025, pending resolution by the shareholders' meeting.

Advantages summary



German quality



Competitive pricing

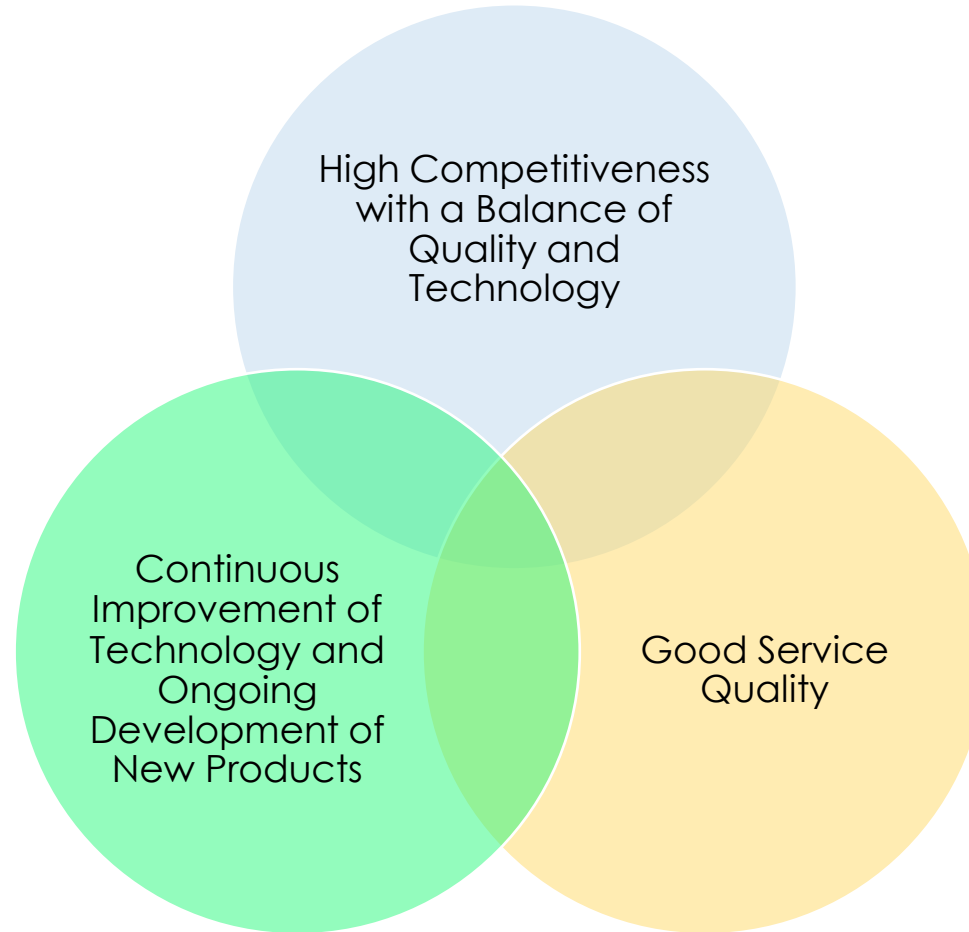

Taiwanese flexibility

CHIEFTEK PRECISION CO., LTD.

Not only for users, but also for designers
cpc's products inspire you!
Together with cpc to achieve new levels of innovation!

cpcStudio

PLC / IDE platform

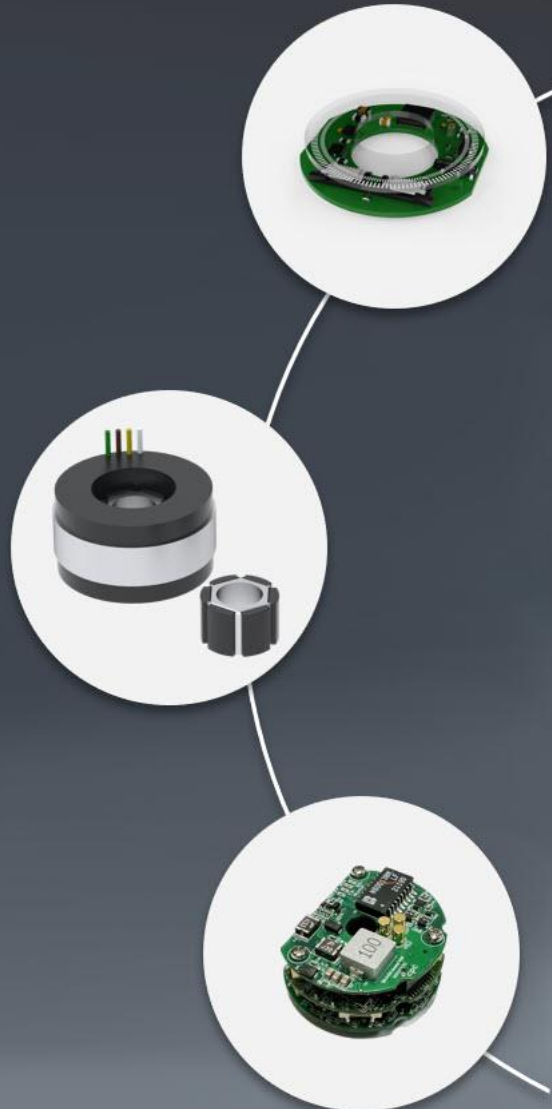
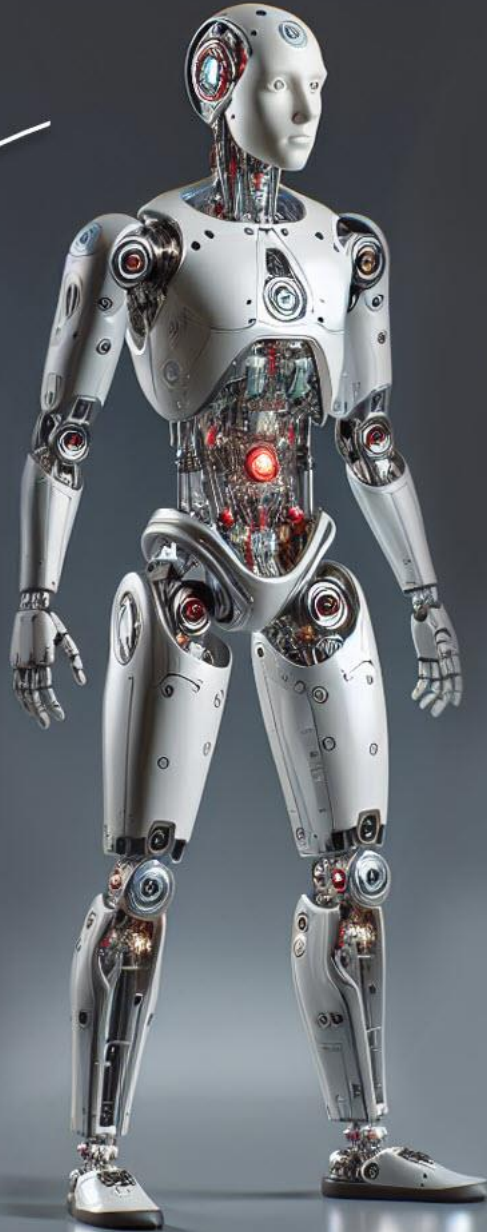

CHIEFTEK PRECISION CO., LTD.

Not only for users, but also for designers
cpc's products inspire you!
Together with cpc to achieve new levels of innovation!



CHIEFTEK PRECISION CO., LTD.

Not only for users, but also for designers

cpc's products inspire you!

Together with cpc to achieve new levels of innovation!

cpcRobot

cpcStudio

cpcCells

cpc YouTube

